

Synco™ 700



Heating Controller

RMH760B

- Heating controller of modular design for medium-size or large buildings with own heat source or a district heating connection. Can be used as a heating circuit controller and / or primary controller, boiler controller or DHW controller
- 41 programmed plant types
- Menu-driven operation with separate operator unit (plug-in type or detached)
- Konnex bus connection facility for operation and process information

Use

Types of buildings

- Office and administrative buildings
- Commercial buildings and shops
- Schools
- Hospitals
- Industrial buildings and workshops
- Apartment blocks and terraced houses

Types of plant

- Heating sections of ventilation and air conditioning plant
- Distribution zones of ventilation and air conditioning plant
- Heating systems with own heat generation
- Heating systems with direct or indirect district heating connection
- Heating groups of larger plant (e.g. community heating systems)
- Basic load heating systems

Functions

Note

Several of the functions listed necessitate extension modules. Refer to page 9 ff.

Control loops and control outputs

- Maximum 6 control systems with modulating output (3-position or DC 0...10 V):
 - Modulating burner
 - Heating circuit with mixing valve
 - Precontrol with mixing valve
 - Maintained boiler return temperature with mixing valve
- Control of a maximum of 6 pumps (single pumps or twin pumps)

Heating circuit control

- Control of a maximum of 3 individual heating circuits (independently)

Functions per heating circuit

- Weather-compensated flow temperature control with own outside sensor
- Mixing or pump heating circuit
- Room operating modes:
 - AUTO: Automatic changeover between 3 setpoints according to the time program
 - Comfort: Continuous heating to the Comfort setpoint
 - Precomfort: Continuous heating to the Precomfort setpoint
 - Economy: Continuous heating to the Economy setpoint
 - Protection: Heating to the setpoint of protective mode, if required
 - Delivery of current operating mode to 2 relays
- 7-day program with a maximum of 6 switching points per day
- Holiday functions:
 - Holiday and special day program with up to 16 periods per year
 - Selectable room operating mode for holidays
 - Time program for special days
- Adjustable setpoints for the room operating modes
- Adjustable room temperature influence
- Optimum start / stop control
- Boost heating and quick setback
- Room model for room functions without room temperature sensor
- Automatic heating limit for demand-dependent control of the heating system with adjustable heating limits for Comfort and Economy mode
- Automatic changeover to summer operation (heating off)
- Maximum limitation of the room temperature
- Minimum and maximum limitation of the flow temperature
- Limitation of the rate of flow temperature increase
- Outside temperature simulation
- Outside temperature-dependent frost protection for the plant
- Remote operation:
 - Remote setpoint adjuster for relative or absolute room setpoint adjustment
 - Multifunctional QAW740 room unit for a choice of heating circuit functions
 - External contacts for changeover of operating mode, timer function, etc.

Functions for all heating circuits

- Adjustable solar compensation
- Adjustable wind compensation

District heating functions

- Raising the reduced room temperature when the outside temperature drops
- Outside temperature-dependent constant-shifting-constant maximum limitation of the return temperature
- Reception of heat meter pulses for limiting the flow rate or the output

Boiler temperature control

- Control of the boiler temperature with a 1-stage, 2-stage or modulating burner (modulating burner with modulating 3-position or DC 0...10 V control, with checkback signal)
- Acquisition of the flue gas temperature, with alarm when limit value is reached
- Acquisition of the pump's flow rate
- Maximum and minimum limitation of the boiler temperature
- Maintained boiler return temperature controlled via mixing valve (3-position or DC 0...10 V), or bypass pump
- Control of a shutoff valve, with checkback signal
- Selection of boiler operating mode
- Limitation of the burner's minimum running time and of the return temperature
- Protective boiler startup
- Release of boiler
- Flue gas measuring mode (boiler test mode, chimney sweep function)
- 3 fault inputs, preconfigured for overpressure, underpressure, and water shortage
- Burner hours run meter and burner start counter

Main control

- Acquisition and evaluation of heat requests (via Konnex bus, external setpoint, external DHW request, and frost protection)
- Demand-compensated main control via mixing valve (3-position or modulating), or of the system pump installed in the main flow
- Minimum and maximum limitation of the main flow temperature
- Shifting maximum limitation of the main return temperature
- Maximum limitation of the main return temperature during DHW heating
- Reception of heat meter pulses for limiting the flow rate or the output

Precontrol

- Acquisition and evaluation of heat requests (via Konnex bus, external setpoint, external DHW request, and frost protection)
- Demand-compensated precontrol via mixing valve (3-position or modulating), or of the system pump installed in the flow
- Minimum and maximum limitation of the flow temperature
- Shifting maximum limitation of the main temperature
- Maximum limitation of the return temperature during DHW heating
- Reception of heat meter pulses for limiting the flow rate or the output

DHW heating

- Several DHW variants available:
 - Storage tank charging via internal heat exchanger
 - Storage tank charging via external heat exchanger (optionally with maintained secondary temperature)
 - Storage tank charging with electric immersion heater
 - Direct DHW consumption via heat exchanger
- Downstream consumer control (control of the DHW temperature at the tap)
- Maximum limitation of the return temperature
- Proof of flow with flow switch
- Reception of heat meter pulses for limiting the flow rate or the output
- Legionella function
- 7-day time switch with a maximum of 6 switching points per day for DHW heating
- 7-day time switch with a maximum of 6 switching points per day for the circulating pump
- Operating modes:
 - AUTO: Automatic changeover between Normal and Reduced in accordance with the time program
 - Continuously Normal
 - Continuously Reduced
 - Protection

- Holiday functions
 - Selectable DHW operating mode for holidays
 - Holiday and special day program with 16 periods per year
 - Time program for special days
- External contact for changeover of operating mode

General functions for all control loops

Yearly clock	Yearly clock with automatic summer- / wintertime changeover.
Measuring and signal inputs	All measuring and signal inputs are configurable. Signals can be: <ul style="list-style-type: none"> • LG-Ni 1000 • DC 0...10 V • Pt 1000 • T1 • NTC 575 • Digital
Data acquisition	4 meters are available for acquiring consumption values. <ul style="list-style-type: none"> • Suited for handling pulses delivered by gas, hot water, cold water and electricity meters • Pulse counting in Wh, kWh, MWh, kJ, MJ, GJ, ml, l, m³, heat cost units, BTU, or with no unit
Other control functions	<ul style="list-style-type: none"> • Control of actuators (3-position or DC 0...10 V) • Pump control • Control of twin pumps • Indication of heat demand • Configurable relays
Supervisory and protective functions	<ul style="list-style-type: none"> • Valve overrun, valve kick • Pump overrun, pump kick • Frost protection for the building • Supervision of overloads • Fault indication via red LED • Fault relay • Handling of status and fault status signals
Bus functions	<ul style="list-style-type: none"> • Remote operation of Konnex functions with RMZ792 bus operator unit • Display of fault status messages received from other devices on the bus • Delivery of common fault status messages of all devices on the bus to a fault relay • Time synchronization • Passing on and adoption of outside temperature signal • Sending yearly clock data to other controllers, or reception of yearly clock data from other controllers • Sending the 7-day or yearly program for holidays / special days to other controllers, or reception of the program from other controllers • Delivery and reception of heat demand signals • Common control strategy of a ventilation controller and heating controller for controlling the same room

Universal transmission and reception zones

Device RMH760B allows for universal data exchange via own terminals as well as via terminals of extension modules RMZ78x.

Data between devices is exchanged via KNX bus.

Universal inputs, digital and analog outputs of RMH760B can be used as transmission objects (for transmission zones).

Universal inputs of RMH760B can be used as reception objects (in reception zones).

- Transmission zones:
Universal inputs (N.X1...A9(2).X6)
Digital outputs (N.Q1...A9(2).Q4)
Analog outputs (N.Y1...A9(2).Y2)
- Reception zones:
Universal inputs (N.X1...A9(2).X6)

Examples for not allowed applications

The following applications or input/output values may **not** be implemented using universal transmission and reception zones:

- Safety-relevant plants and equipment (e.g. fire alarm off, smoke extraction, frost protection function).
- If request "Simultaneous start condition of plants" exists.
- Applications where communications failure of transmission or reception zones may cause damage.
- Time-critical control paths or control paths with greater degree of difficulty (e.g. speed control via pressure, humidity).
- Main controlled variables that must be available.
- Acquisition and evaluation of pulses.

Note: After RMH760B power-up, it may take some time until the bus signals are available. This may result in faulty plant behavior in the case of transmission and reception zone applications that are not allowed.

Logic function blocks

4 freely configurable logic function blocks are available to process multiple logically linked universal input variables.

- Configurable logic functions: AND, NAND, OR, NOR, EXOR and EXNOR
- Adjustable switch-on and switch-off delay and minimum switch-on and switch-off time.
- Operating switch (AUTO, ON, OFF), configurable for manual control.

Comparators

2 comparators are available to compare two analog input signals.

- Output signal with adjustable switch on and off delay as well as adjustable minimum switch on and off period.

Service and operating functions

- Wiring test
- Display of setpoints, actual values and active limitations
- Data protection

Note

For a detailed description of all controller functions, refer to the Basic Documentation (P3133).

Type summary

Heating controllers	Device	Type	Data sheet
	Heating controller	RMH760B-1	N3133

Selection of languages

The following languages are loaded:

English, German, French, Italian, Spanish, Portuguese, Dutch, Danish, Finnish, Norwegian, Swedish, Polish, Czech, Hungarian, Russian, Slovakian, Bulgarian, Greek, Romanian, Slovenian, Serbian, Croatian, Turkish.

Note

Starting from software version 3.00, all languages are included in the same type.

Operator and service units

Operator unit (plug-in type)	RMZ790	N3111
Operator unit (detached)	RMZ791	N3112
Bus operator unit	RMZ792	N3113
Service tool	OCI700.1	N5655
Service terminal + service tool	OCI702 + ACS790	A6V10438951 N5649
Web server	OZW772...	N5701

Extension modules and accessories

Heating circuit module	RMZ782B	N3136
DHW module	RMZ783B	N3136
Universal module with 4 universal inputs and 4 relay outputs	RMZ787	N3146
Universal module with 6 universal inputs, 2 analog and 4 relay outputs	RMZ789	N3146
Module connector for detached extension modules	RMZ780	N3138

Ordering

When ordering, please specify the quantity, product name and type code for the device, e.g: Heating controller **RMH760B-1**.

The required operator unit and extension modules must be ordered as separate items.

Equipment combinations

Possible equipment combinations are available in HIT.

Product documentation

Documentation type	Document no.
Product range description: Synco™ 700	CE1S3110en
Basic documentation, detailed description of all functions	CE1P3133en
Installation instructions: RMH760B, RMK770	CE1G3133xx
Operating instructions: RMH760B, RMK770	CE1B3133xx
Data sheet for KNX bus	CE1N3127en
Synco KNX S-mode data points	CE1Y3110en
Basic documentation: Communication via KNX bus	CE1P3127en

Mode of operation

The controller is supplied complete with 41 standard types of heating plants ready programmed. Most of them necessitate the use of extension modules. All plant types can be matched to the respective requirements (e.g. configuration as a main controller (district heating connection), configuration of twin pumps, etc.).

In addition, an empty application is provided.

With the help of the operator unit, the controller facilitates the following:

- Activation of a programmed application
- Modification of a programmed application
- Free configuration of applications
- Optimization of settings

For more detailed information, refer to the Basic Documentation (P3133).

Note

For a short description and diagrams of all plant types, refer to page 177 ff.

Overview

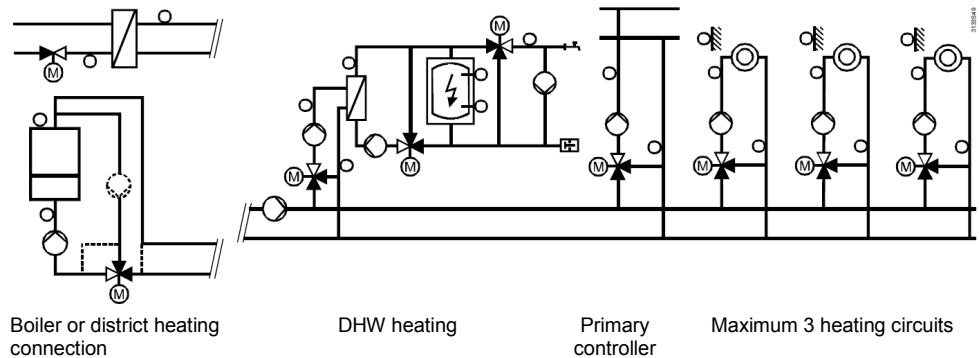

Boiler hydraulics

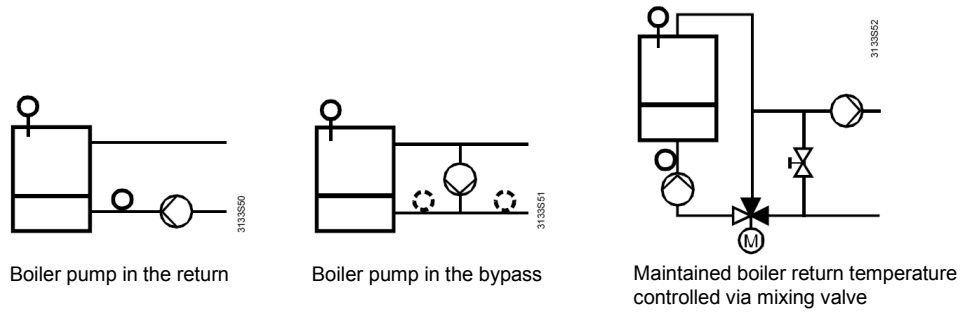

Main controller (district heating connection)

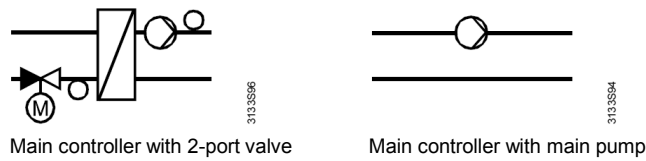

Primary controller

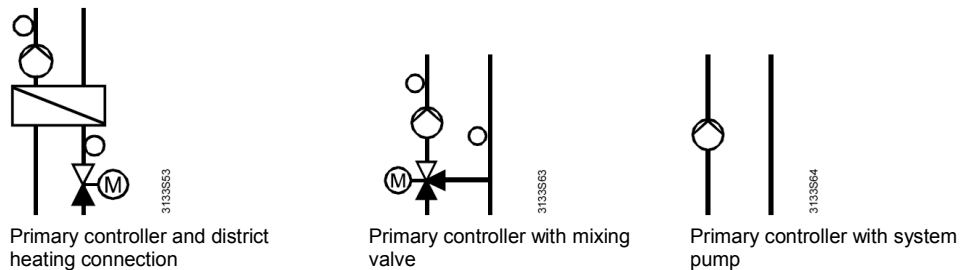

DHW heating variants

BW 0

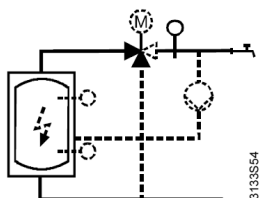

BW 1

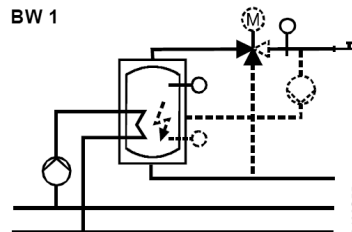

BW 2

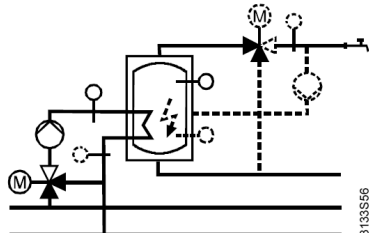

BW 3

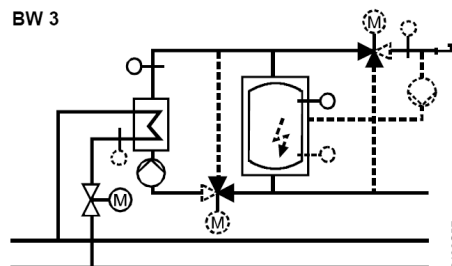

BW 4

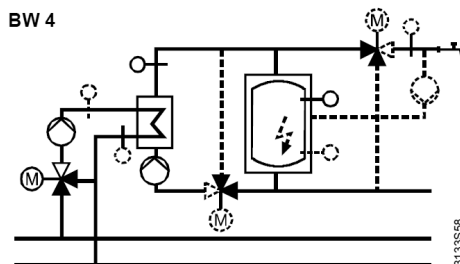

BW 5

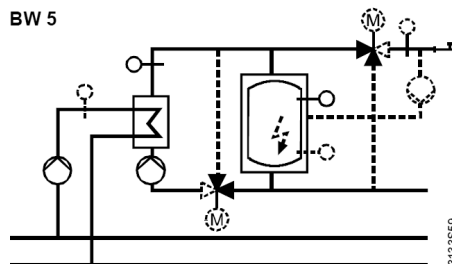

BW 6

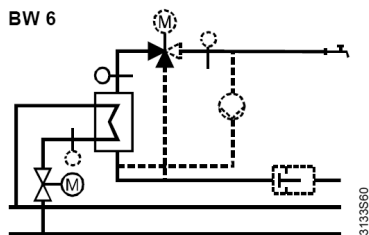

Heating circuit

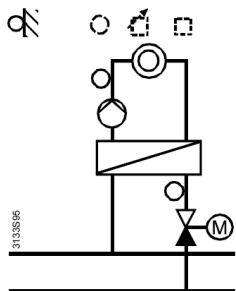

Heating circuit and district heating connection

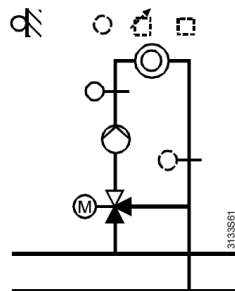

Mixing heating circuit

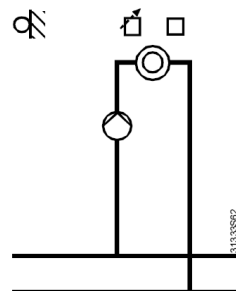

Pump heating circuit

Pump control

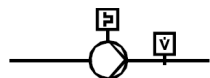

Control of a single pump with supervision of flow and overload

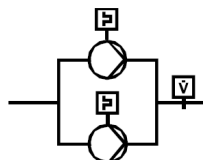

Control of a twin pump with supervision of flow and overload

Commissioning

When commissioning the plant, the relevant plant type is to be entered. Then, all associated functions, terminal assignments, settings and displays will automatically be activated and parameters not required will be deactivated.

For more detailed information, refer to the Basic Documentation (P3133).

Use of extension modules

Extension modules are used when the standard number of inputs and outputs are not sufficient to cover all required functions:

Type of extension module	Universal inputs	Analog outputs	Relay outputs	
			NO	Changeover
Heating circuit module RMZ782B	3	1	2	1
DHW module RMZ783B	4	1	3	2
Universal module RMZ787	4	—	3	1
Universal module RMZ789	6	2	2	2

A **maximum of 4** extension modules can be used while giving consideration to the following restrictions:

- Maximum 2 heating circuit modules RMZ782B
- Maximum 1 DHW module RMZ783B
- Maximum 1 universal module RMZ787
- Maximum 2 universal modules RMZ789

Mechanical design

Operating, display and connecting elements

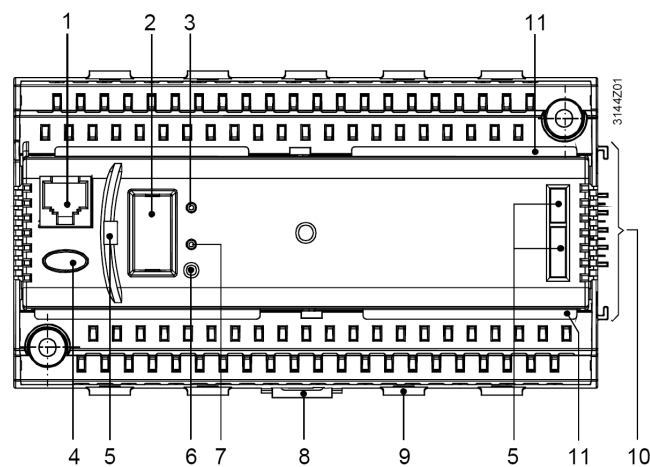

- 1 Connection facility for service interface (RJ45 socket)
- 2 Connection facility for operator unit (with removable cover)
- 3 LED (green) for indication of operation
- 4 Fault button with LED (red) for indication of faults and resetting
- 5 Openings for plug-in type operator unit RMZ790
- 6 Button for assignment of device address
- 7 LED (red) for indication of the programming process
- 8 Mounting facility for fitting the unit to a top hat rail
- 9 Fixing facility for a cable tie
- 10 Electrical and mechanical connecting elements for extension module
- 11 Rest for the terminal cover

Makeup

The heating controller consists of terminal base and insert. It has a plastic housing with the printed circuit boards, 2 terminal levels and carries the connecting elements (electrical and mechanical) for one extension module.

The controller can be fitted to a top hat rail conforming to EN 60 715-TH 35-7.5, or can be mounted directly on a wall.

Operation is facilitated via a plug-in type or detached operator unit (refer to “Type summary“).



- The controller can be used in connection with a **maximum of 4** extension modules
- The controller operates on AC 24 V. Operating voltage must conform to the requirements of SELV / PELV (safety extra low-voltage / protective extra low-voltage)
- The transformers used must be safety isolating transformers featuring double insulation to EN 60742 and EN 61558-2-6; they must be suited for 100 % duty
- Fuses, switches, wiring and grounding must be in compliance with local safety regulations for electrical installations
- Sensor wires should not be run parallel to mains carrying cables powering actuators, pumps, etc.
- To define the details of configuration and to generate the plant connection diagrams, the following pieces of documentation are helpful:
 - Configuration diagrams, contained in the Basic Documentation (P3132)
 - Application Sheets
- The reference room for control with a room temperature sensor should be the space that cools down quickest. That room must not be equipped with thermostatic radiator valves, and manual valves must be locked in their fully open position

Mounting and installation notes

- Controller and extension modules are designed for:
 - Mounting in standard control cabinets conforming to DIN 43880
 - Wall mounting on existing top hat rails (EN 50022-35×7,5)
 - Wall mounting with 2 fixing screws
 - Flush panel mounting
- Not permitted are wet or damp spaces. The permissible environmental conditions must be observed
- If the controller shall not be operated inside a control panel, the detached RMZ791 operator unit can be used in place of the RMZ790 plug-in type
- Prior to mounting the controller, the system must be disconnected from power
- **The controller insert must not be removed from the terminal base!**
- If extension modules are used, they must be attached to the right side of the controller in the correct order and in accordance with the internal configuration
- The extension modules require no wiring between them or from the modules to the controller. The electrical connections are made automatically when attaching the modules. If it is not possible to arrange all required extension modules side by side, the first of the detached modules must be connected to the previous module or to the controller using the RMZ780 module connector. In that case, the maximum cable length is 10 m
- All connection terminals for protective extra low-voltage (sensors, data bus) are located in the upper half of the unit, those for mains voltage (actuators and pumps) at the bottom
- Each terminal (spring cage terminals) can accommodate only one solid wire or one stranded wire. To connect the cables, the insulation must be stripped for 7 to 8 mm. To introduce the cables into the spring cage terminals and to remove them, a screwdriver of size 0 or 1 is required
- Cable strain relief can be ensured with the help of the fixing facility for cable ties
- The controller is supplied complete with Installation Instructions and Operating Instructions

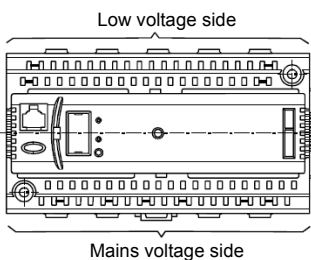

Commissioning notes

- The configuration and parameters of the standard applications programmed in the controller can be changed any time on site by personnel trained by Siemens who have the respective access rights to the plant, using the RMZ790 or RMZ791 operator unit or, online or offline, with the help of the service tool
- During the commissioning process, the application remains deactivated and the outputs are in a defined off state. During this period of time, no process and alarm signals are delivered to the bus
- On completion of the configuration, the controller will automatically be restarted
- When leaving the commissioning pages, the peripheral devices (including the extension modules) connected to the universal inputs will automatically be checked and identified. If, later, a peripheral device is missing, a fault status message will be output
- The operator unit can be removed and plugged in or connected while the controller is in operation
- Adaptations required due to specific plant conditions must be recorded and the relevant document should be stored in the control panel
- The procedure to be followed when starting up the plant for the first time is described in the Installation Instructions

Disposal notes



The device is considered an electronics device for disposal in terms of European Directive 2012/19/EU and may not be disposed of as domestic garbage.

- Dispose of the device through channels provided for this purpose.
- Comply with all local and currently applicable laws and regulations..

Technical data

Power supply (G, G0)	Rated voltage	AC 24 V \pm 20 % (SELV)
	Requirements for external safety isolating transformer (100 % duty, max. 320 VA)	to EN 60 742 / EN 61 558-2-6
	Frequency	50/60 Hz
	Power consumption (excl. modules)	12 VA
	External supply line protection	fuse max. 10 A (slow release) or automatic circuit breaker max. 13 A tripping characteristic B, C, D according to EN 60898 or power supply with current limiting at 10 A
Functional data	Reserve of clock	
	Typically	48 h
	Minimum	12 h
Analog inputs X1...X6	Sensors	
	Passive	1 or 2 LG-Ni 1000, T1, Pt 1000, NTC 575
	Active	DC 0...10 V
	Signal sources	
	Passive	0...2500 Ω
Digital inputs X1...X6	Active	DC 0...10 V
	Contact sensing	
	Voltage	DC 15 V
	Current	5 mA
	Requirements for status and impulse contacts	
Positioning output Y1, Y2	Signal coupling	potential-free
	Type of contact	maintained or impulse contacts
	Insulating strength against mains potential	AC 3750 V to EN 60730
	Permissible resistance	
	Contacts closed	max. 200 Ω
	Contacts open	min. 50 k Ω
	Output voltage	DC 0...10 V
	Output current	\pm 1 mA
	Max. loading	continuous short-circuit
	 Switching outputs Q1x...Q5x	External supply line protection
Wire fuse (slow)		max. 10 A
Automatic line cutout		max. 13 A
Release characteristic		B, C, D to EN 60898
Cable length		max. 300 m
Relay contacts		
Switching voltage		max. AC 250 V / min. AC 19 V
AC current		max. 4 A res., 3 A ind. (cos φ = 0.6)
At 250 V		min. 5 mA
At 19 V		min. 20 mA
Switch-on current		max. 10 A (1 s)
Contact life at AC 250 V		Guide values:
0.1 A (res.)		2×10^7 switching cycles
NO contact at 0.5 A (res.)		4×10^6 switching cycles
Changeover contact at 0.5 A (res.)		2×10^6 switching cycles
NO contact at 4 A (res.)	3×10^5 switching cycles	
Changeover contact at 4 A (res.)	1×10^5 switching cycles	
Reduction factor at ind. (cos φ = 0.6)	0.85	
Insulating strength		
between relay contacts and system electronics (reinforced insulation)	AC 3750 V to EN 60 730-1	
between neighboring relay contacts (operational insulation) Q1 \leftrightarrow Q2; Q3 \leftrightarrow Q4 \leftrightarrow Q5	AC 1250 V to EN 60 730-1	
between relay groups (reinforced insulation) (Q1, Q2) \leftrightarrow (Q3, Q4) \leftrightarrow (Q5)	AC 3750 V to EN 60 730-1	

Power supply external devices (G1)	Voltage	AC 24 V	
	Current	max. 4 A	
Interfaces	Konnex bus		
	Type of interface	Konnex TP1	
	Bus loading number	2.5	
	Bus power supply (decentral, can be switched off)	25 mA	
	Power failure of short duration to EN 50 090-2-2	100 ms with one extension module	
	Extension bus		
	Connector specification	4 contacts SELV / PELV	
	Number of plugging cycles	max. 10	
	Service tool connection facility	RJ45 socket	
Permissible cable lengths	For passive measuring and positioning signals*		
	LG-Ni 1000	max. 300 m	
	0...1000 Ω	max. 300 m	
	1000...1235 Ω	max. 300 m	
	Contact sensing	max. 300 m	
	For DC 0...10 V measuring and control signals	refer to Data Sheet of signal-delivering device	
	For Konnex bus	max. 700 m	
	Type of cable	2-core, unshielded, twisted pairs	
	* Measuring errors can be corrected via the "Settings > Inputs" menu		
Electrical connections	Connection terminals	spring cage terminals	
	Solid wires	0.6 mm dia...2.5 mm ²	
	Stranded wires without ferrules	0.25...2.5 mm ²	
	Stranded wires with ferrules	0.25...1.5 mm ²	
	Konnex bus connection	wires cannot be interchanged	
Protective data	Degree of protection of housing to IEC 60 529	IP20 (when installed)	
	Safety class to EN 60 730	device suited for use in equipment of safety class II	
Ambient conditions	Operation	to IEC 60 721-3-3	
	Climatic conditions	class 3K5	
	Temperature (housing with electronics)	0...50 °C	
	Humidity	5...95 % r.h. (non-condensing)	
	Mechanical conditions	class 3M2	
	Transport	to IEC 60 721-3-2	
	Climatic conditions	class 2K3	
	Temperature	-25...+70 °C	
	Humidity	<95 % r. h.	
	Mechanical conditions	class 2M2	
Classifications to EN 60 730	Mode of operation, automatic controls	type 1B	
	Degree of contamination, controls' environment	2	
	Software class	A	
	Rated surge voltage	4000 V	
	Temperature for ball-pressure test of housing	125 °C	
Standards, directives and approvals	Product standard	EN 60730-1	Automatic electronic controls for household and similar use.
	Product family standard	EN 50491-3	General requirements for Home and Building Electronic Systems (HBES) and Building Automation and Control Systems (BACS).
	Electromagnetic compatibility (application area)		For residential, commercial, and industrial environments.
	EU conformity (CE)		CE1T3110xx
	RCM conformity		CE1T3110en_C1*)
	EAC conformity		Eurasia-conformity CE1E3110en01
Environmental compatibility	The environmental product declaration contains data on environmentally compatible product design and assessments (RoHS compliance, materials composition, packaging, environmental benefit, disposal)		

Eco design and labeling directives	Controller class	Efficiency gain
Application with up to three room temperature sensors and one outdoor temperature sensor and modulating control	VIII	5.0%
Application with one room temperature sensor and one outdoor temperature sensor and modulating control	VI	4.0%
Application with one outdoor temperature sensor and modulating control	II	2.0%
Application with up to three room temperature sensors and one outdoor temperature sensor and on/off control	VII	3.5%
Application with one room temperature sensor and one outdoor temperature sensor and on/off control	VII	3.5%
Application with one outdoor temperature sensor and on/off control	III	1.5%

Materials and colors

Terminal base	polycarbonate, RAL 7035 (light-grey)
Controller insert	polycarbonate, RAL 7035 (light-grey)
Packaging	corrugated cardboard
Weight	
Net weight excl. packaging	0.490 kg

*) Documents can be downloaded at the following Internet address: <http://siemens.com/bt/download>

Connection terminals

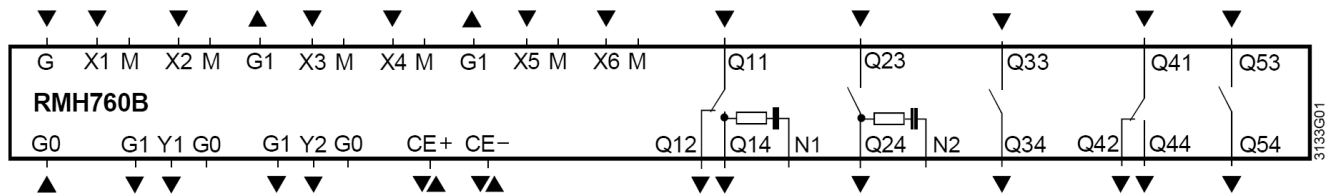

CE+	Konnex bus data line, positive
CE-	Konnex bus data line, negative
G, G0	Operating voltage AC 24 V
G0	System neutral for signal output
G1	Output voltage AC 24 V for powering external active sensors, signal sources and monitors
M	Measuring neutral for signal input
N1, N2	Radio interference suppression element for 3-position actuators
Q1..., Q4...	Potential-free relay outputs (changeover contacts) for AC 24...230 V
Q2..., Q3..., Q5...	Potential-free relay outputs (NO contacts) for AC 24...230 V
X1...X6	Universal signal inputs for LG-Ni 1000, 2× LG-Ni 1000 (averaging), T1, Pt 1000, DC 0...10 V, 0...1000 Ω (setpoint), 1000...1175 Ω (rel. setpoint), contact sensing (potential-free)
Y1, Y2	Control or status outputs DC 0...10 V

Notes

- Each terminal (spring cage terminals) can accommodate only one solid wire or one stranded wire
- Double terminals are internally interconnected
- With 3-position control of actuators operating on AC 230 V, the radio interference suppression element must be activated. For that purpose, terminal N1 is to be connected to the neutral conductor and a wire link is to be fitted between terminals N1 and N2

Connection examples

Various low-voltage connections

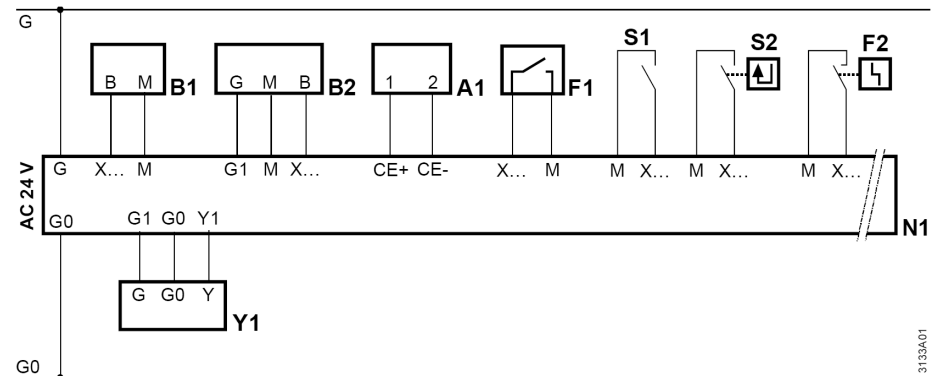

A1	Konnex device
B1	Passive sensor (signal source)
B2	Active sensor (signal source)
F1	Fault contact (e.g. thermostat)
F2	Fault contact (e.g. pressure switch) on the burner
N1	Heating controller RMH760B
S1	Manual switch, service switch, etc.
S2	Operational signal (e.g. from burner or shutoff valve)
Y1	Actuator with DC 0...10 V control input

Connection of 3-position actuators

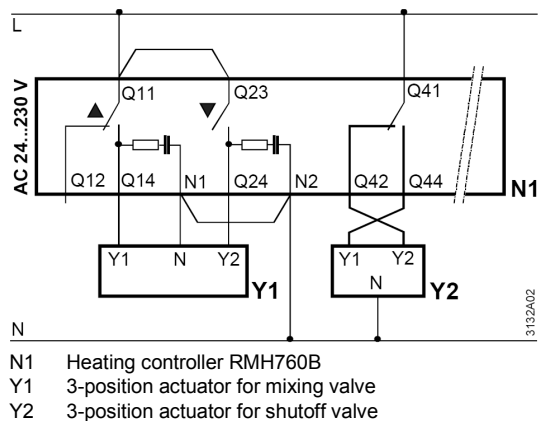

Connection of 1 twin pump or 2 single pumps

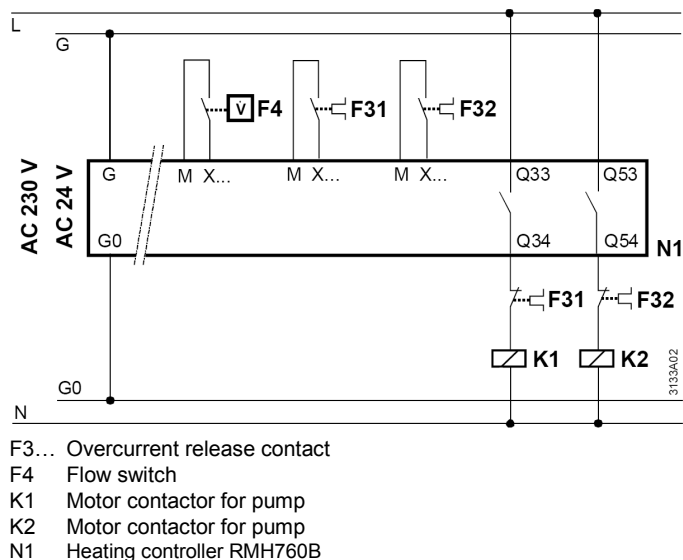

Connection of safety loop for a 2-stage burner

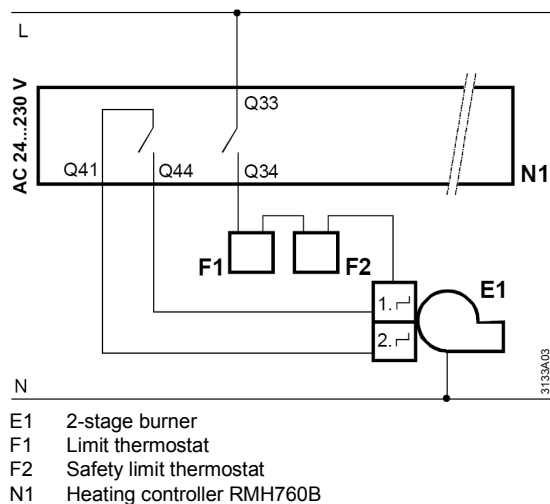

Plant types

Plant type	Description	Plant diagram
H0-1	N1: DHW circuit with storage tank flow controlled via mixing valve and charging pump, connected directly to uncontrolled header (DHW 2 variant)	<p>H0-1</p>
H0-2	N1: Weather-compensated heating circuit control with mixing valve and circulating pump, connected directly to uncontrolled header	<p>H0-2</p>
H0-3	A3: DHW circuit (DHW 2) N1: Heating circuit	<p>H0-3</p>
H0-4	N1: Heating circuit A2: Heating circuit	<p>H0-4</p>
H0-5	A3: DHW circuit (DHW 2) N1: Heating circuit A2: Heating circuit	<p>H0-5</p>
H0-6	N1: Heating circuit A2(1): Heating circuit A2(1): Heating circuit	<p>H0-6</p>
H0-7	A3: DHW circuit (DHW 2) N1: Heating circuit A2(1): Heating circuit A2(2): Heating circuit	<p>H0-7</p>

Plant type	Description	Plant diagram
H1-0	N1: Main controller (district heating connection with heat exchanger), control of the secondary flow temperature with 2-port valve in the primary return, heat supply to internal and external consumers	
H1-1	N1: Main controller A3: DHW circuit, storage tank charging from heat exchanger controlled via mixing valve, with primary and secondary pump (DHW 4)	
H1-2	N1: Main controller A2: Weather-compensated heating circuit control with mixing valve and circulating pump, connected to secondary side of header	
H1-3	N1: Main controller A3: DHW circuit (DHW 4) A2: Heating circuit	
H1-4	N1: Main controller A2(1): Heating circuit A2(2): Heating circuit	
H1-5	N1: Main controller A3: DHW circuit (DHW 4) A2(1): Heating circuit A2(2): Heating circuit	
H2-0	N1: Demand-compensated primary controller with mixing valve and circulating pump; heat supply to external consumers	

Plant type	Description	Plant diagram
H2-1	<p>N1: Primary controller</p> <p>A3: DHW circuit with storage tank flow controlled via mixing valve, with charging pump (DHW 2)</p>	
H2-2	<p>N1: Primary controller</p> <p>A2: Weather-compensated heating circuit control with mixing valve and circulating pump</p>	
H2-3	<p>N1: Primary controller</p> <p>A3: DHW circuit (DHW 2)</p> <p>A2: Heating circuit</p>	
H2-4	<p>N1: Primary controller</p> <p>A2(1): Heating circuit</p> <p>A2(2): Heating circuit</p>	
H2-5	<p>N1: Primary controller</p> <p>A3: DHW circuit (DHW 2)</p> <p>A2(1): Heating circuit</p> <p>A2(2): Heating circuit</p>	
H3-0	<p>N1: Boiler temperature control with 1-stage burner and boiler pump</p>	
H3-1	<p>N1: Boiler temperature control</p> <p>A3: DHW circuit with storage tank flow controlled via mixing valve, with charging pump (DHW 2)</p>	

Plant type	Description	Plant diagram
H3-2	N1: Boiler temperature control A2: Weather-compensated heating circuit control with mixing valve and circulating pump	
H3-3	N1: Boiler temperature control A3: DHW circuit (DHW 2) A2: Heating circuit	
H3-4	N1: Boiler temperature control A2(1): Heating circuit A2(2): Heating circuit	
H3-5	N1: Boiler temperature control A3: DHW circuit (DHW 2) A2(1): Heating circuit A2(2): Heating circuit	
H4-0	N1: Boiler temperature control with 1-stage burner and boiler pump, maintained boiler return temperature controlled via mixing valve	
H4-1	N1: Boiler temperature control A3: DHW circuit with storage tank flow controlled via mixing valve, with charging pump (DHW 2)	
H4-2	N1: Boiler temperature control A2: Weather-compensated heating circuit control with mixing valve and circulating pump	

Plant type	Description	Plant diagram
H4-3	N1: Boiler temperature control A3: DHW circuit (DHW 2) A2: Heating circuit	
H4-4	N1: Boiler temperature control A2(1): Heating circuit A2(2): Heating circuit	
H4-5	N1: Boiler temperature control A3: DHW circuit (DHW 2) A2(1): Heating circuit A2(2): Heating circuit	
H5-2	N1: Weather-compensated heating circuit control from heat exchanger connected to uncontrolled header, with 2-port valve in the primary return	
H5-3	A3: DHW circuit with storage tank charging from heat exchanger connected to uncontrolled header (DHW 3) N1: Heating circuit	
H5-4	N1: Heating circuit A2: Heating circuit	
H5-5	A3: DHW circuit (DHW 3) N1: Heating circuit A2: Heating circuit	

Plant type	Description	Plant diagram
H5-6	N1: Heating circuit A2(1): Heating circuit A2(2): Heating circuit	
H5-7	A3: DHW circuit (DHW 3) N1: Heating circuit A2(1): Heating circuits A2(2): Heating circuits	
H6-1	N1: Direct DHW consumption from heat exchanger connected to uncontrolled header, with circulating pump (DHW 6)	
H6-3	N1: DHW circuit (DHW 6) and weather-compensated heating circuit control from heat exchangers, with 2-port valve in the primary return	
H6-5	N1: DHW circuit and heating circuit A2 Heating circuit	
H6-7	N1: DHW circuit (DHW 6) and heating circuit A2(1): Heating circuit A2(2): Heating circuit	

- N. Connection terminals of heating controller N1, RMH760B
- A2. Connection terminals of heating circuit module RMZ782B
- A2(1) Connection terminals of 1st heating circuit module RMZ782B, if 2 heating circuit modules are used
- A2(2) Connection terminals of 2nd heating circuit module RMZ782B, if 2 heating circuit modules are used
- A3. Connection terminals of DHW module RMZ783B
- Q1 Relay terminals, consisting of Q11, Q12 and Q14 (e.g. actuator)
- Q2 Relay terminals, consisting of Q23 and Q24 (e.g. actuator)
- Q3 Relay terminals, consisting of Q33 and Q34 (e.g. heating circuit pump)
- Q4 Relay terminals, consisting of Q41, Q42 and Q44 (e.g. storage tank charging pump)
- Q5 Relay terminals, consisting of Q53 and Q54 (e.g. boiler pump)
- X1 Configurable input for main controlled variable (e.g. flow temperature)
- X2 Configurable input for auxiliary controlled variable (e.g. outside temperature)
- X3 Configurable input for auxiliary controlled variable (e.g. return temperature)
- X4 Configurable input for auxiliary controlled variable (e.g. storage tank flow sensor on secondary side)
- X5 Configurable input for auxiliary controlled variable (e.g. storage tank flow sensor on secondary side)

Issued by
Siemens Switzerland Ltd
Building Technologies Division
International Headquarters
Gubelstrasse 22
6301 Zug
Switzerland
Tel. +41 41-724 24 24
www.siemens.com/buildingtechnologies

© Siemens Switzerland Ltd, 2006
Technical specifications and availability subject to change without notice.